

**TANGENS 1M**  
230V AC  
LED max 1x10W E27  
CE V IP20 ⊕

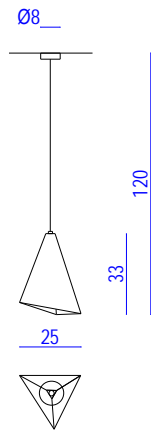

**TANGENS 1D**  
230V AC  
LED max 1x10W E27  
CE V IP20 ⊕

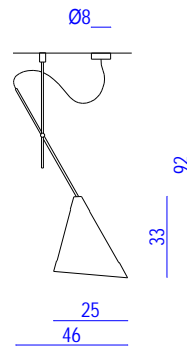

**TANGENS 1DV**  
230V AC  
LED max 1x10W E27  
CE V IP20 ⊕

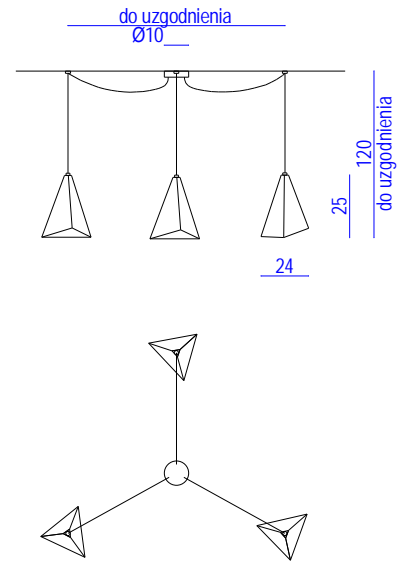

**TANGENS 3MV**  
230V AC  
LED max 3x10W E27  
CE V IP20 ⊕

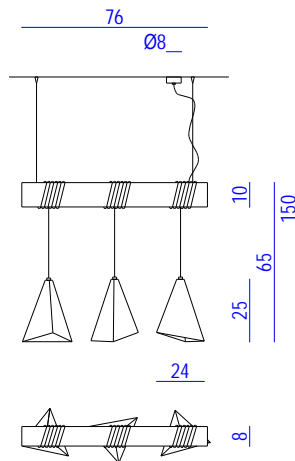

**TANGENS 3M**  
230V AC  
LED max 3x10W E27  
CE V IP20 ⊕

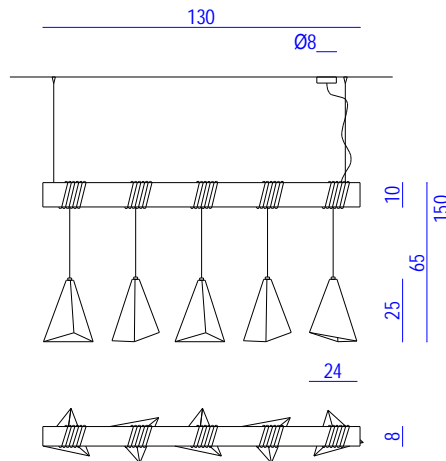

**TANGENS 5M**  
230V AC  
LED max 5x10W E27  
CE V IP20 ⊕

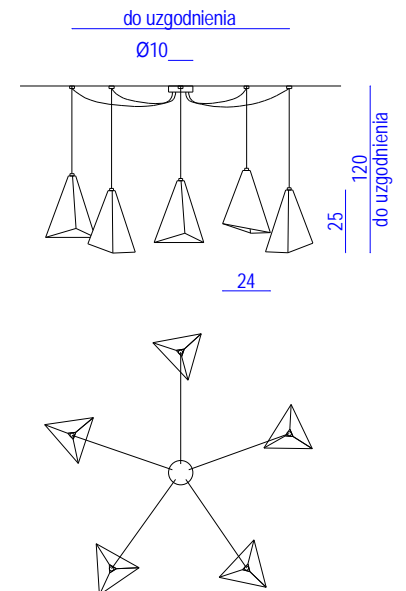

**TANGENS 5MV**  
230V AC  
LED max 5x10W E27  
CE V IP20 ⊕

Możliwość samodzielnego zmniejszenia fabrycznej długości lampy po montażu.  
Zwiększenie długości lampy - na specjalne zamówienie.  
Inna ilość kloszy w dowolnej konfiguracji - na specjalne zamówienie.

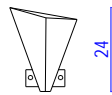

19



TANGENS K1  
230V AC  
LED max 1x8W E27  
CE  IP20 

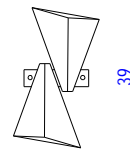

24



TANGENS K2  
230V AC  
LED max 2x6W E27  
CE  IP20 

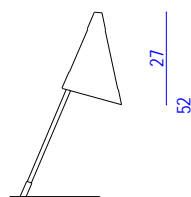

31

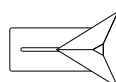

TANGENS B1  
230V AC  
LED max 1x10W E27  
CE  IP20 

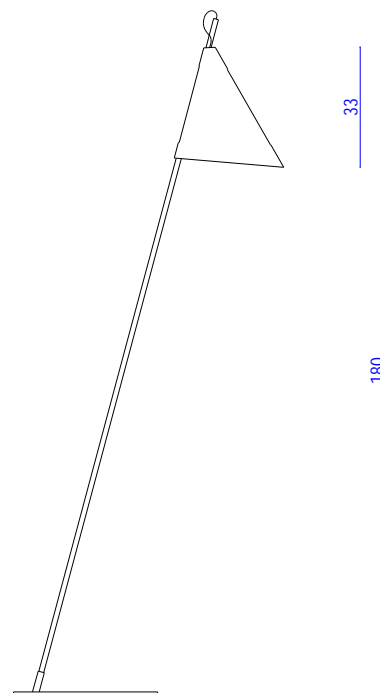

75

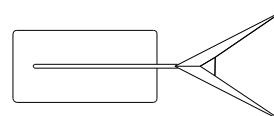

TANGENS S1  
230V AC  
LED max 1x10W E27  
CE  IP20 